

Align-Pilates



Catalogue 2024



Who We Are



Align-Pilates was founded in 2010 with the objective of making commercial quality Pilates equipment more affordable outside North America, so that Pilates Studios could flourish in other parts of the world as they have there. Setting up your own successful Pilates Studio has always been an exciting prospect – Align-Pilates' mission is to make this a more viable and profitable prospect whilst offering innovative, high performance, reliable equipment that you and your customers will love.

Our Experience

Align-Pilates have been producing our own apparatus for fourteen years with our sister brand, Pilates-Mad. Pilates-Mad have been the UK's leading Pilates matwork equipment brand since 2001. With the extensive Pilates knowledge of its customers, Align-Pilates has created Europe's own Pilates apparatus company. Align-Pilates is pleased to present its latest evolution of Pilates apparatus, which blends tried and tested reliability with rapid, customer led design refinements.

Our Service In The UK

When it comes to service, we stand alone amongst the Pilates apparatus brands in the UK. We hold all of our products in stock, together with an extensive range of spares and accessories in our own warehouses. We offer a complete delivery and install service using our own staff and vehicles and we are open throughout the UK working week to handle your enquiries as and when they arise. These are simple things in themselves but take them away and it can play havoc with the smooth running of your Pilates business! Outside the UK, we appoint stocking Distributors so that you can receive a similar service wherever you buy from.

Try Our Apparatus In The UK

With Pilates apparatus there is nothing like experiencing the equipment first hand and finding out what it is really like. We actively encourage visits to our showroom at our UK headquarters, which is open in normal office hours – please just let us know when you want to come! We also regularly attend Exhibitions and Shows – check the link on the back cover for upcoming events.

Try Our Apparatus Outside The UK

Align-Pilates has a growing following around the world with Distributors in Australia, Canada, Costa Rica, China, Denmark, Finland, France, Germany, Greece, Hong Kong, Hungary, Ireland, Israel, Italy, Malaysia, Netherlands, Poland, Romania, Saudi Arabia, Slovakia, Slovenia, South Korea, Spain, and Thailand, with more being added all the time. Many of our Distributors have permanent showrooms where you can try the equipment. Please see the link on the back cover of the catalogue to find a Distributor or International trade show near you.



Contents



Reformers	4-29
At A Glance	4-5
Commercial Reformers	6-25
A8-Pro Reformer	6-9
C8-Pro Reformer	10-13
C8-S Pro Reformer	14-17
M8-Pro Reformer	18-21
R8-Pro Reformer	22-25
Home Reformers	26-29
F3 Folding Reformer	26-29
Cadillacs & Towers	30-35
Half Cadillac	30-31
Full Cadillacs	32-33
Fuse Ladder II	34-35
Ladder Barrel & Chair	36-39
Ladder Barrel RC	36-37
Combo Chair III	38-39
Boxes & Arcs	40-41
Accessories	42-48
Reformer Accessories	42-46
Matwork Accessories	47-48
Reformer Comparison	49
Apparel & Grip Socks	50-51

FIND OUT MORE

**SHOP
ONLINE**



**WATCH
VIDEOS**



**USER
GUIDES**



Reformers

At A Glance

Discover the comprehensive range of Reformers, catering to various preferences for both commercial and home use. For more detail, please see our Reformer Comparison on page 49. **All of our Reformers feature:**

8 Carriage Wheels

Silent Rope & Pulley System

Adjustable Rope Risers

Multi-Position Footbar

Nickel-Plated Korean Music Wire Springs

Off-Centre Shoulder Rests



A8-Pro Pilates Reformer

Page 6 >

Our flagship Reformer. With an oversized carriage, the longest carriage travel of any standard Pilates Reformer on the market, and adjustability including three leg heights, this Reformer is perfect for larger/ taller clients who require extended range of motion.

Widest Carriage/Longest Travel

RC Spring Bar

Takes Half Cadillac

Commercial Warranty



C8-Pro Pilates Reformer

Page 10 >

The C8-Pro is the ultimate C-Series Reformer, featuring an oversize aluminium profile and Footbar and an 8 PU wheel carriage system for the quietest and lowest maintenance ride available.

Stackable & Standable

RC Spring Bar

Takes Half & Full Cadillacs

Commercial Warranty



C8-S Pro Pilates Reformer

Page 14 >

The C8-S Pro is an evolution from our best-selling C8-Pro Pilates Reformer. Designed with a focus on aesthetics and neat-flowing lines, the C8-S Pro is perfect for the more style oriented studios.

Stackable & Standable

RC Spring Bar

Takes Half Cadillac

Commercial Warranty

M8-Pro Pilates Reformer

Page 18 >

The Align-Pilates M8-Pro Pilates Reformer is crafted from extremely durable North American maple and designed to marry classical styling with contemporary functionality.

North American Maple Frame

RC Spring Bar



Takes Half Cadillac

Commercial Warranty

R8-Pro Pilates Reformer Black

Page 22 >

The R8-Pro is our first "light commercial" Reformer, meaning it's ideal for both home studios or those commercial set ups with light usage. Its classic Pilates Reformer geometry – combined with contemporary features – make this a great all round Reformer.

Standable

RC Spring Bar

Space for 5th Spring

Light Commercial Warranty



R8-Pro Pilates Reformer White

Page 22 >

The white version of the R8-Pro maintains the design and functionality of the original black R8-Pro, but offers a stylish alternative white stainless steel finish, making the R8-Pro incredibly versatile both in features and aesthetic.

Standable

RC Spring Bar

Space for 5th Spring

Light Commercial Warranty



F3 Folding Pilates Reformer

Page 26 >

The F3 Folding Reformer builds upon the world's most popular folding Reformer, the F2, to offer an innovative carriage that never crosses the fold line, for the smoothest ride, whilst still being easy to store at home.

Foldable

Wheel Open Or Closed

Lightest Reformer

Home Warranty





A8-Pro



The Align-Pilates A8-Pro Pilates Reformer is our flagship commercial Pilates Reformer.

The A8-Pro runs on 8 PU wheels, which creates an extremely smooth and quiet ride, improved handling of cross loading forces, and reduced maintenance.

The A8-Pro includes our patent-pending Rapid Change Spring Bar, which allows swift and hassle-free spring bar adjustments. With a focus on efficiency, you can change the carriage position

without removing any springs. Additionally, we have introduced a new and improved rope adjustment system that enables precise adjustments. With this conveniently located near the headrest, you can effortlessly fine-tune the rope lengths to achieve optimal positioning for you or your clients. We understand the importance of seamless and accurate adjustments, particularly in a Studio setting where time and precision are paramount.



Our A8-Pro offers refined performance, extensive adjustability but importantly it offers a luxurious oversize carriage and the longest travel of any standard Pilates Reformer on the market. Simply, this Reformer has been designed for those seeking a spacious carriage bed either for yourself, or for a breadth of clients in a Studio setting.

Now in its fourth generation, the A8-Pro is the result of over eight years of development. The A8-Pro can be built with a choice of 3 interchangeable leg heights:

Low Leg (28cm), Standard (42cm), or High Legs (64cm), making the A8-Pro a truly future-proof and versatile investment. The A8-Pro has been designed for studio, rehab, and private use with the innovative design offering a host of easy adjustments to provide complete flexibility. The A8-Pro uses all the same accessories as the previous A2 models so that the A2 and A8-Pro can easily coexist in the same studio, sharing Jump Boards, Mattress Converters, and Platform Extenders.

A8-Pro



What's Included?

- Adjustable Silent Foot Strap with fluffy cover
- Integral standing platform
- Pair of Silent Double Loop Straps
- 5 nickel plated quality music wire springs in 3 different strengths: 2 × light, 2 × medium and 1 × strong

Optional Extras

- Gondola Maple Pole 60"
- Platform Extender
- 3 Leg Heights (28cm, 42cm, or 64cm)
- Jump Board
- Cardio Jump Dome
- Sitting Boxes
- Planking Handles
- Mattress Converter
- Neck Pillow
- Half Cadillac

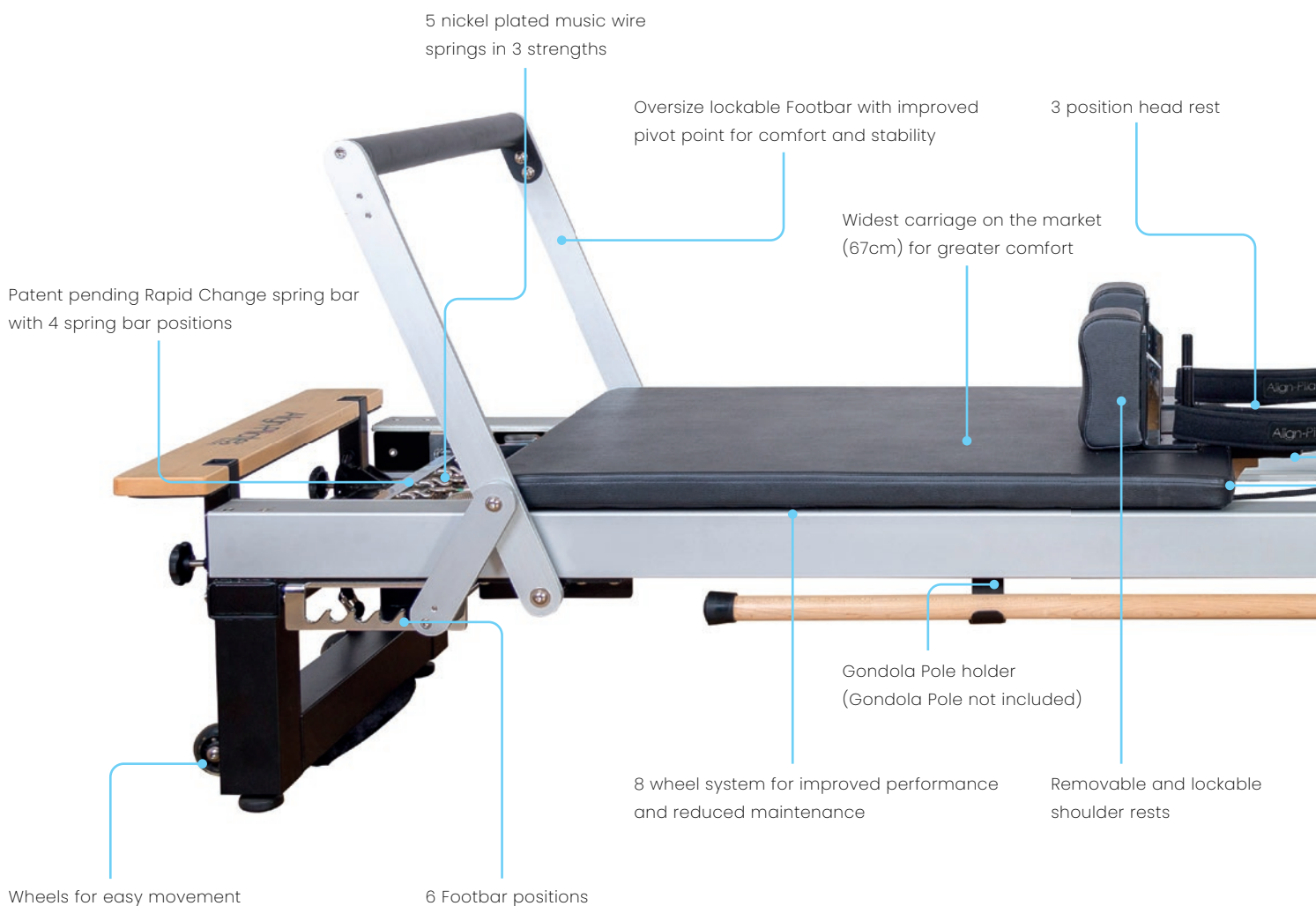

Find Out More



FEATURES
VIDEO



ASSEMBLY
VIDEO

Product Options

Product	Dimensions	Code
A8-Pro With Low Legs	257cm (L) × 75cm (W) × 28cm (H)	PAPREFORMERA8L
A8-Pro With Standard Legs	257cm (L) × 75cm (W) × 42cm (H)	PAPREFORMERA8S
A8-Pro With High Legs	257cm (L) × 75cm (W) × 64cm (H)	PAPREFORMERA8R
A8-Pro With Half Cadillac	257cm (L) × 75cm (W) × -189cm (H)	PAPHALFCADSETA8S
A8-Pro Pilates Reformer With Standard Legs & Plank Handles	263cm (L) × 75cm (W) × 26cm (H)	PAPREFORMERA8SP

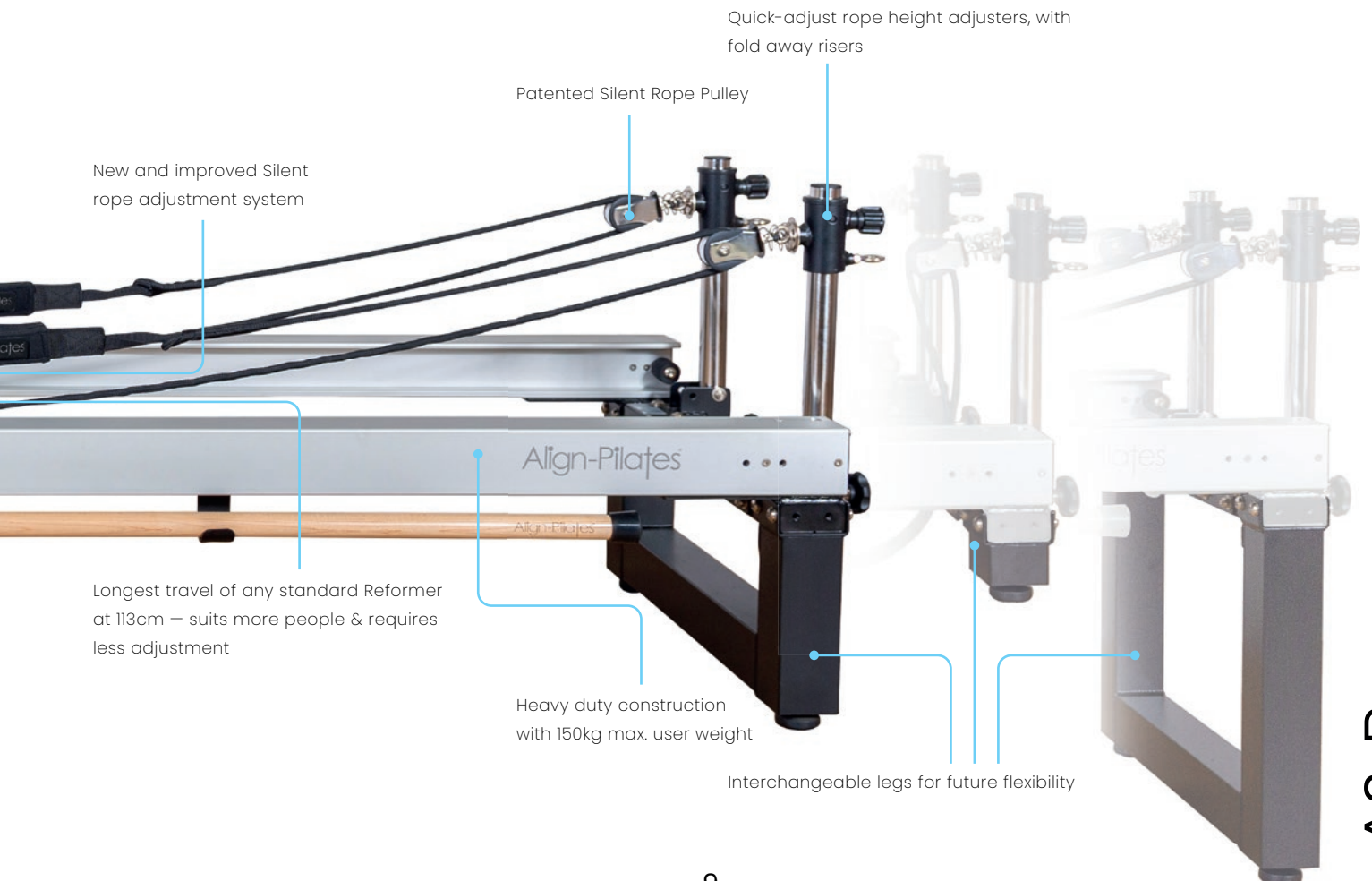

A8-Pro



C8-Pro



The C8-Pro is the ultimate C-Series Reformer, featuring an oversize aluminium profile and Footbar and an 8 PU wheel carriage system for the quietest and lowest maintenance ride available.

Like all Align-Pilates commercial Reformers, the C8-Pro features our patent pending Rapid Change (RC) spring bar for the easiest and quickest adjustment on the market.

Many Pilates professionals choose their Reformer based on the ride characteristics and the biggest determinant of that is the number and type of wheels. The number and material of the wheels determine the resistance of the carriage, the sound the machine makes, the handling of cross loading and the amount of maintenance required. The C8-Pro uses 8 'roller blade style' wheels which are designed to give a quieter and softer ride with greater rolling resistance.



Among other premium Reformers, the C8-Pro has the advantage of versatility: Its size provides a comfortable range of motion to suit a variety of clients but is also easy to move, stack, or stand — and is our only Reformer which can accept both a Full and Half Cadillac. This makes it perfect for a multifunctional studio which needs to offer a variety of classes within a single space.

The C8-Pro's Rapid Change spring bar radically alters the ease and speed of adjusting your Reformer, which is particularly beneficial for those running group classes (where the C8-Pro really excels). The spring bar can simply be adjusted with the springs attached, with one hand, and in a single action, which saves up to 12 additional actions when compared with most standard spring bars.

C8-Pro



What's Included?

- Adjustable Silent Foot Strap with fluffy cover
- Integral standing platform
- Pair of Silent Double Loop Straps
- 5 nickel plated quality music wire springs in 3 different strengths: 2 × light, 2 × medium and 1 × strong

Optional Extras

- Gondola Maple Pole 60"
- Platform Extender
- Leg Extensions (raise bed to 44cm)
- Freestanding Legs
- Jump Board
- Sitting Boxes
- Planking Handles
- Mattress Converter
- Neck Pillow
- Half Cadillac
- Full Cadillac

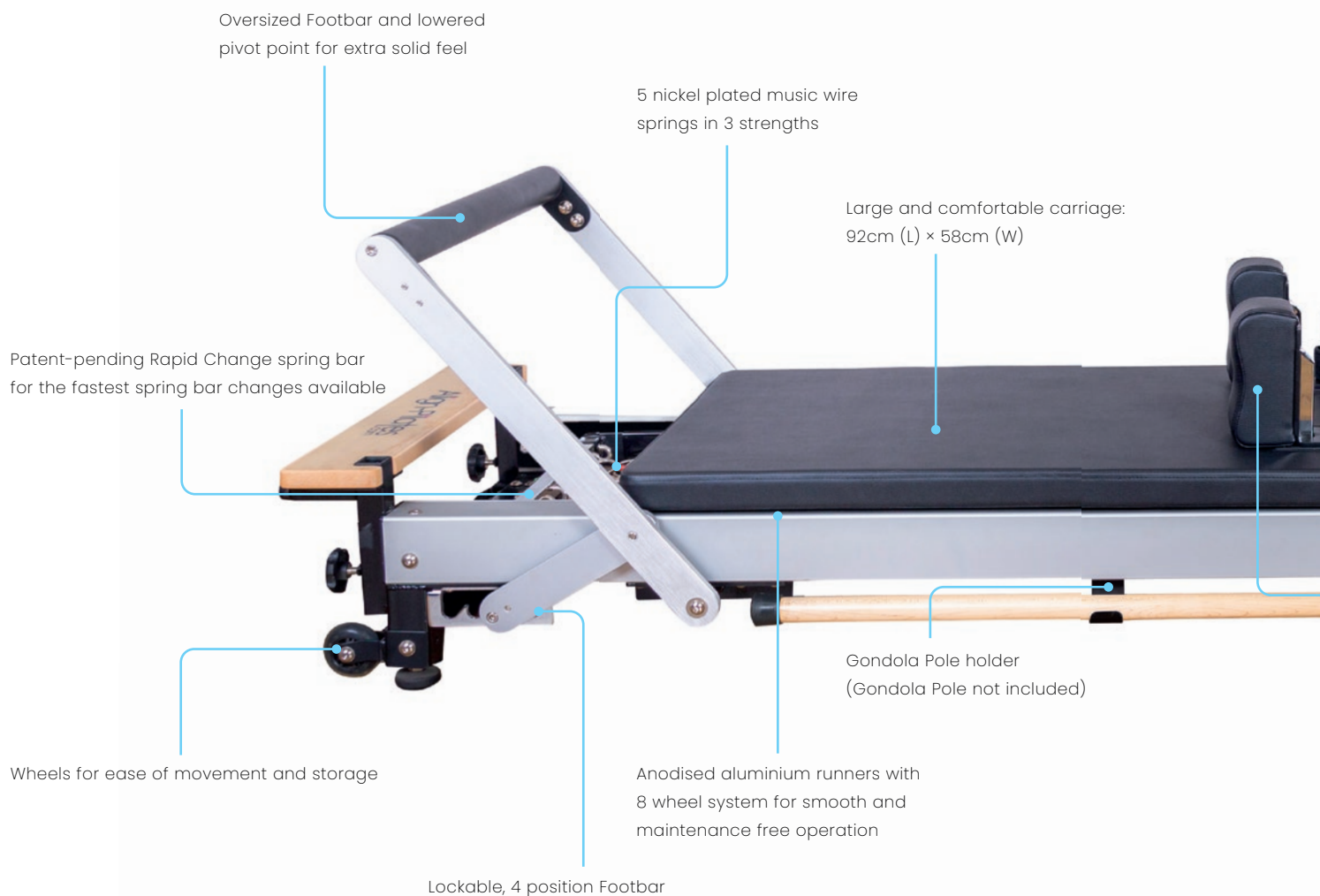

Find Out More



FEATURES
VIDEO



ASSEMBLY
VIDEO

Product Options

Product	Dimensions	Code
C8-Pro Pilates Reformer	244cm (L) × 66cm (W) × 26cm (H)	PAPREFORMERC8
C8-Pro Pilates Reformer With Leg Extensions	244cm (L) × 66cm (W) × 44cm (H)	PAPREFORMERC8L
C8-Pro Pilates Reformer With Freestanding Legs	244cm (L) × 66cm (W) × 26cm (H) Standing Height: 240cm	PAPREFORMERC8F
C8-Pro Pilates Reformer With Half Cadillac	244cm (L) × 66cm (W) × ~189cm (H)	PAPC8HALFCAD
C8-Pro Pilates Reformer With Full Cadillac	244cm (L) × 66cm (W) × ~216cm (H)	PAPC8FULLCAD

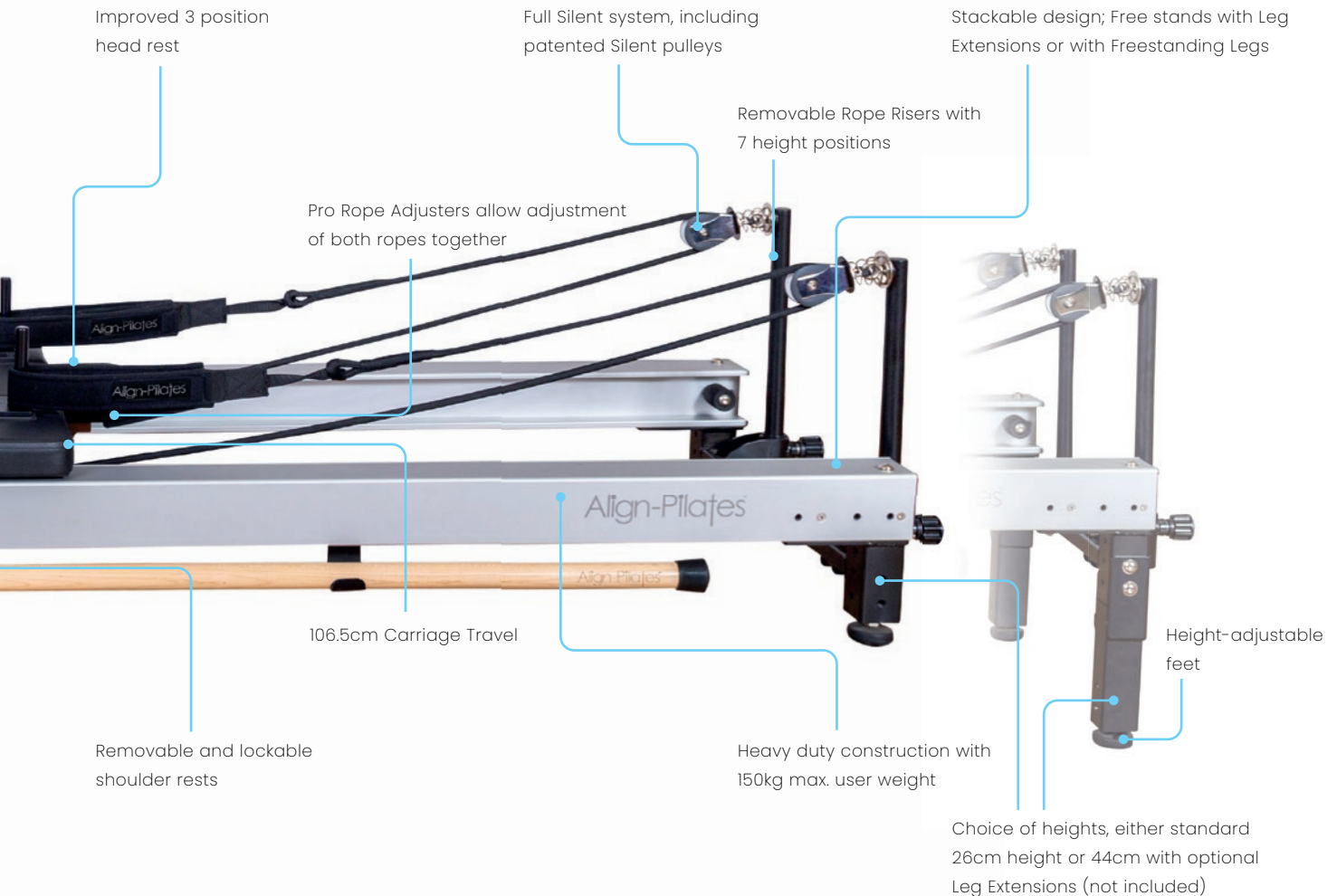



C8-S Pro



The C8-S Pro is an evolution from our best-selling C8-Pro Reformer. Designed with a focus on aesthetics and neat-flowing lines, the C8-S Pro Reformer is perfect for more style oriented Studios.

The C8-S Pro takes the design of the C8-Pro and repackages it in a fresh design with a focus on clean flowing lines, achieved by bringing the standing

platform and rope risers within the frame. The C8-S Pro is particularly aimed at the group Reformer studio and more style-oriented home studio.

The C8-S Pro is operationally almost exactly the same as the C8-Pro, using the same carriage, runner profile, running gear and adjustment systems so you can expect the same smooth and silent user experience



here. For owners of existing C-Series Reformers the C8-S Pro also uses the same Jump Board, Mattress Converter, and Platform Extender. The C8-S Pro comes in a standard height of 26cm which can be raised to 42cm with its optional, almost seamless Leg Extensions.

The differences with the C8-Pro are: 1.5cm less carriage travel (but still an excellent 105cm); very similar but fractionally different Footbar positions; white frame and legs; different Leg Extensions and the inability to have the Full Cadillac attached. On the plus side it looks great and functions beautifully!

C8-S Pro



What's Included?

- Adjustable Silent Foot Strap with fluffy cover
- Integral standing platform
- Pair of Silent Double Loop Straps
- 5 nickel plated quality music wire springs in 3 different strengths: 2 × light, 2 × medium and 1 × strong

Optional Extras

- Gondola Maple Pole 60"
- Platform Extender
- Leg Extensions (raise bed to 42cm)
- Jump Board
- Sitting Boxes
- Planking Handles
- Mattress Converter
- Neck Pillow
- Half Cadillac

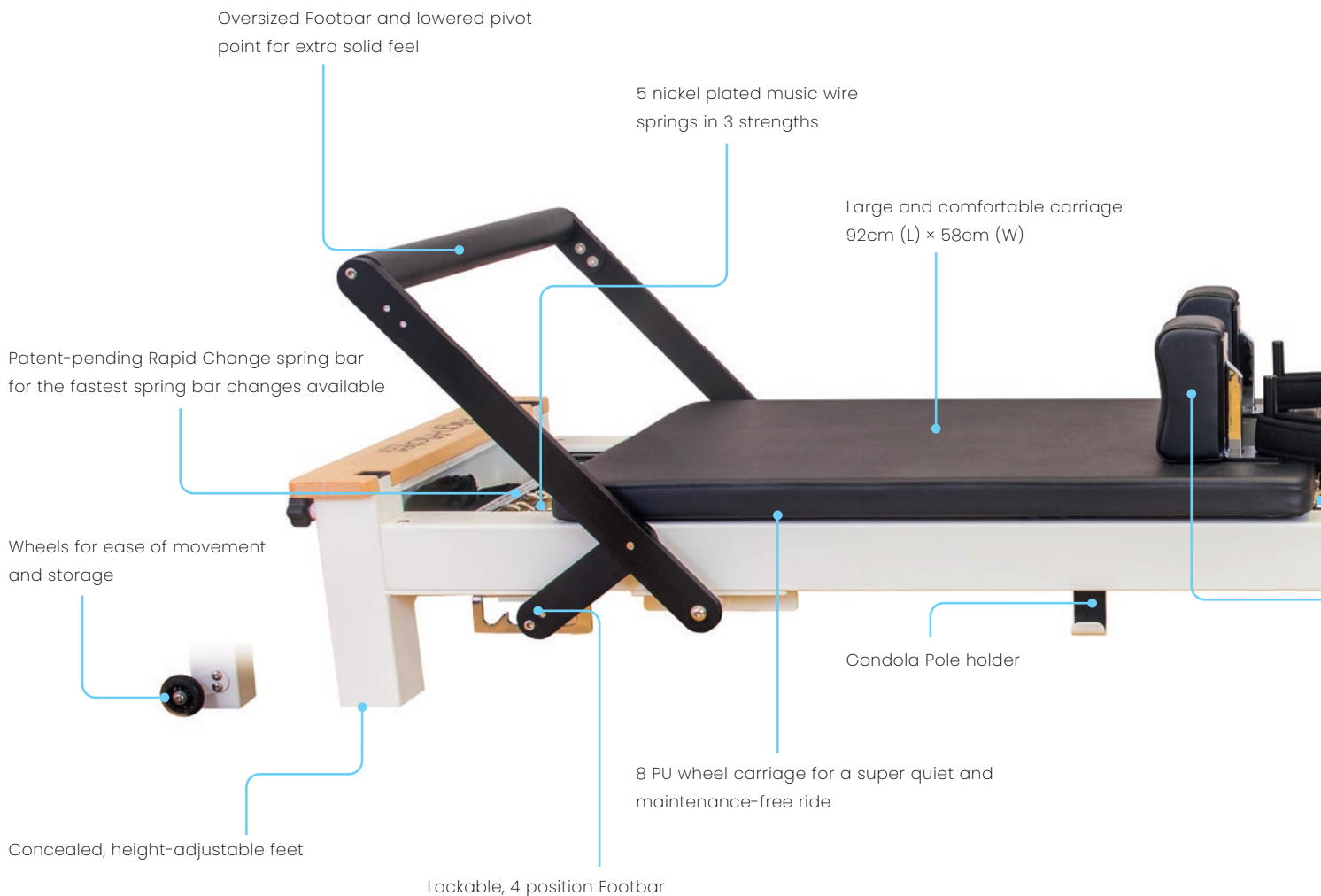

Find Out More



VIEW
ONLINE



ASSEMBLY
VIDEO

Product Options

Product	Dimensions	Code
C8-S Pro Pilates Reformer	243cm (L) × 67cm (W) × 26cm (H)	PAPREFORMERC8S
C8-S Pro Pilates Reformer With Leg Extensions	243cm (L) × 67cm (W) × 42cm (H)	PAPREFORMERC8SL
C8-S Pro Reformer With Half Cadillac	243cm (L) × 67cm (W) × -189cm (H)	PAPC8SHALFCAD

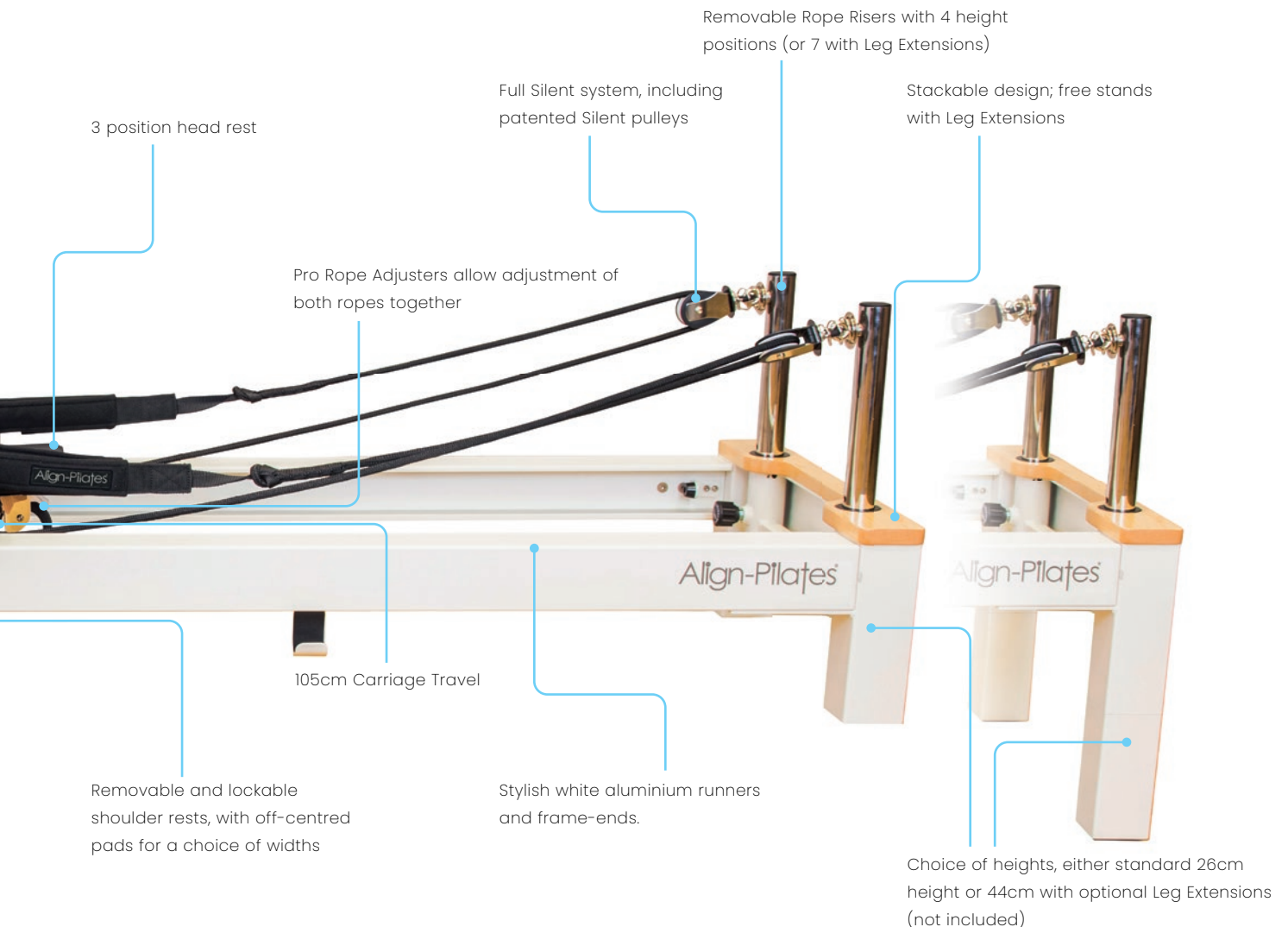



M8-Pro



The Align-Pilates M8-Pro Pilates Reformer is crafted from extremely durable North American maple and designed to marry classical styling with contemporary functionality.

The M8-Pro offers refined performance, whilst offering extensive adjustability, a luxurious oversize carriage, and 104cm of smooth and silent travel. Not only does the M8-Pro deliver outstanding performance with its 8 wheel carriage, but its sleek design and attention to detail make it a visually appealing addition to

any home or studio. The oversized carriage on the M8-Pro easily accommodates a range of body sizes, meaning it not only looks fantastic in one's home, but can accommodate a breadth of clients too in a Studio setting. The innovative design offers a host of easy adjustments to provide complete flexibility in use.

The M8-Pro uses our patent-pending Rapid Change (RC) spring bar, which can be adjusted – with the springs attached – with one hand, without needing



to move a separate carriage stopper. This radically alters the ease and speed of adjusting your Reformer, which is particularly beneficial in a group class environment.

Unlike any other Reformer in our range, the M8-Pro Reformer comes complete with a Pro Sitting Box and Foot Strap. It also comes with a removable maple standing platform which is larger than our other commercial Reformers in our range. It also now features storage hooks for a gondola pole (available

separately) and removable off-centred shoulder rests for a choice of shoulder width positions.

The M8-Pro is incredibly adaptable, with an upholstered Jump Board also available, which is interchangeable with the standing platform. The M8-Pro can also accept a Half Cadillac, converting it into a completely flat bed with a two-part Platform Extender/Mattress Converter.

M8-Pro



What's Included?

- Adjustable Silent Foot Strap with fluffy cover
- Removable standing platform
- Pair of Silent Double Loop Straps
- 5 nickel plated quality music wire springs in 3 different strengths: 2 × light, 2 × medium and 1 × strong
- Pro Sitting Box

Optional Extras

- Gondola Maple Pole 60"
- Platform Extender
- Jump Board
- Other Sitting Boxes
- Mattress Converter
- Neck Pillow
- Half Cadillac

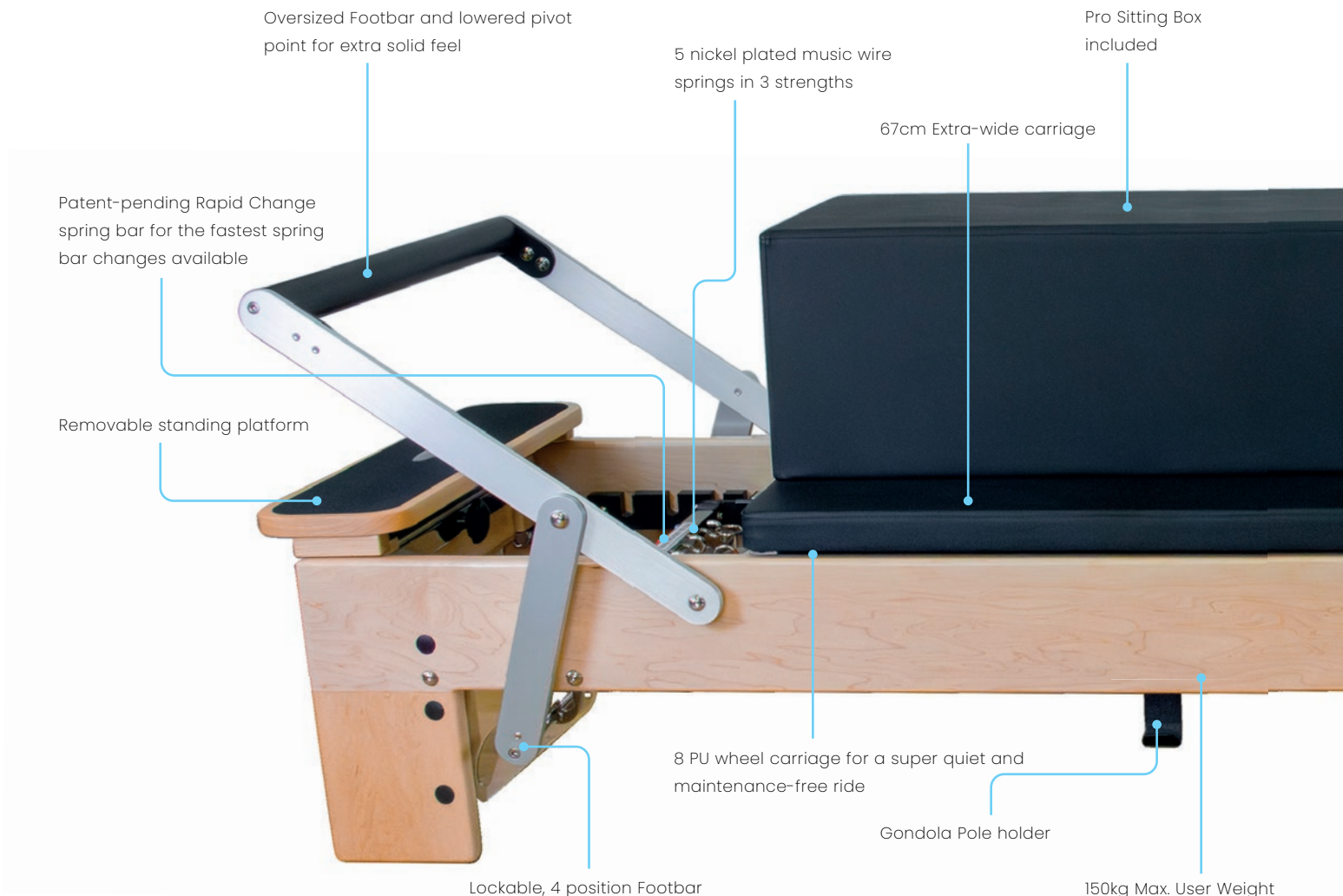

Find Out More



FEATURES
VIDEO



VIEW
ONLINE

Product Options

Product	Dimensions	Code
M8-Pro Maple Wood Pilates Reformer & Sitting Box Bundle	254cm (L) × 76cm (W) × 43cm (H)	PAPREFORMERM8B
M8-Pro Maple Wood Pilates Reformer With Half Cadillac	254cm (L) × 76cm (W) × -189cm (H)	PAPM8HALFCAD

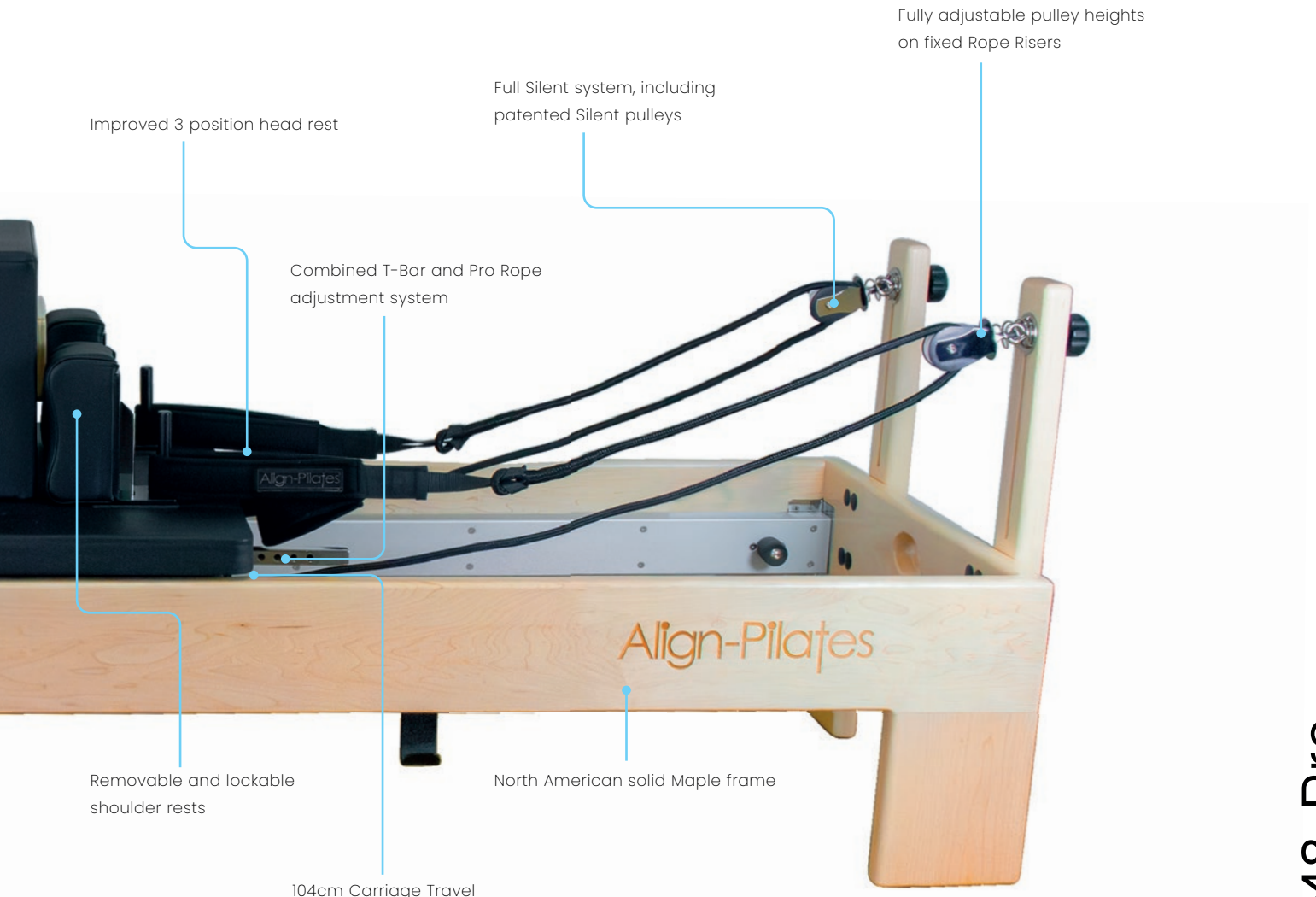



R8-Pro

The R8-Pro is our new entry level light commercial Reformer, available in black or white finish.

The R8 stands for Retro (8 wheel) as the Reformer has been designed to replicate many features of Joseph Pilates's original "classic Reformers". This includes the carriage and Footbar distances, carriage dimensions, spring bar positions, Footbar height, and Reformer height. Whilst the R8-Pro uses height-adjustable rope risers and our Silent Ropes instead of leather straps, the design ensures the pulley position closely resembles that of a classic machine.

Despite these classic features, the R8-Pro is a contemporary Reformer which has been designed with 4 Footbar heights, including a flat position and many rapid adjustment systems.

The R8-Pro comes with 4 springs, but uniquely has the space to add a 5th spring should you wish. It also includes our patented Rapid Change spring bar with 3 Spring Bar positions for quick and seamless carriage position adjustments. The R8-Pro ropes can also be quickly adjusted using our Pro Rope adjusters that conveniently sit behind the shoulder rests.



The R8-Pro is our first Reformer in a “light commercial” category, meaning it’s ideal for both home studios or those commercial set ups with light usage. For a full list of differences, please refer to our Reformer Comparison on our website, but please note that this Reformer cannot accommodate a Half Cadillac Tower.

This is an incredibly compact Reformer which does not sacrifice on quality or performance. You can free-stand the R8-Pro with an optional Jump Board, and it is portable too with wheels to reposition or move,

meaning it’s a great choice for a multi-purpose Studio.

Overall, the R8-Pro is the best value light commercial Reformer on the market. Its appreciation of classic Pilates Reformer geometry – combined with ease of use, longer travel, and a wider range of adjustments to suit different body shapes and sizes – makes this a great all round Reformer and a modern take on a classic theme.

R8-Pro



What's Included?

- Integral standing platform
- Pair of Silent Double Loop Straps
- 4 nickel plated quality music wire springs in 3 different strengths: 1 × light, 1 × medium and 2 × strong (with space for a 5th spring)

Optional Extras

- Platform Extender
- Jump Board
- Sitting Boxes
- Neck Pillow
- Foot Strap

Patent-pending Rapid Change spring bar for the fastest spring bar changes available

4 nickel plated music wire springs in 3 strengths (with space for a 5th spring)

56cm Extra-wide carriage

Off-centred shoulder rests



Wheels for ease of movement and storage

8 PU wheel carriage for a super quiet and maintenance-free ride

120kg Max. User Weight



Height-adjustable feet

Adjustable Footbar with 5 positions

Find Out More



ASSEMBLY
VIDEO



VIEW
ONLINE

Product Options

Product	Dimensions	Code
R8-Pro Pilates Reformer – Black	248cm (L) × 67cm (W) × 23cm (H)	PAPREFORMERR8
R8-Pro Pilates Reformer – White	248cm (L) × 67cm (W) × 23cm (H)	PAPREFORMERR8W

Pro Rope adjustment system
within shoulder rest frame

Full Silent system, including
patented Silent pulleys

Adjustable Rope Risers with 9
heights (with Leg Extensions)

3 position head rest

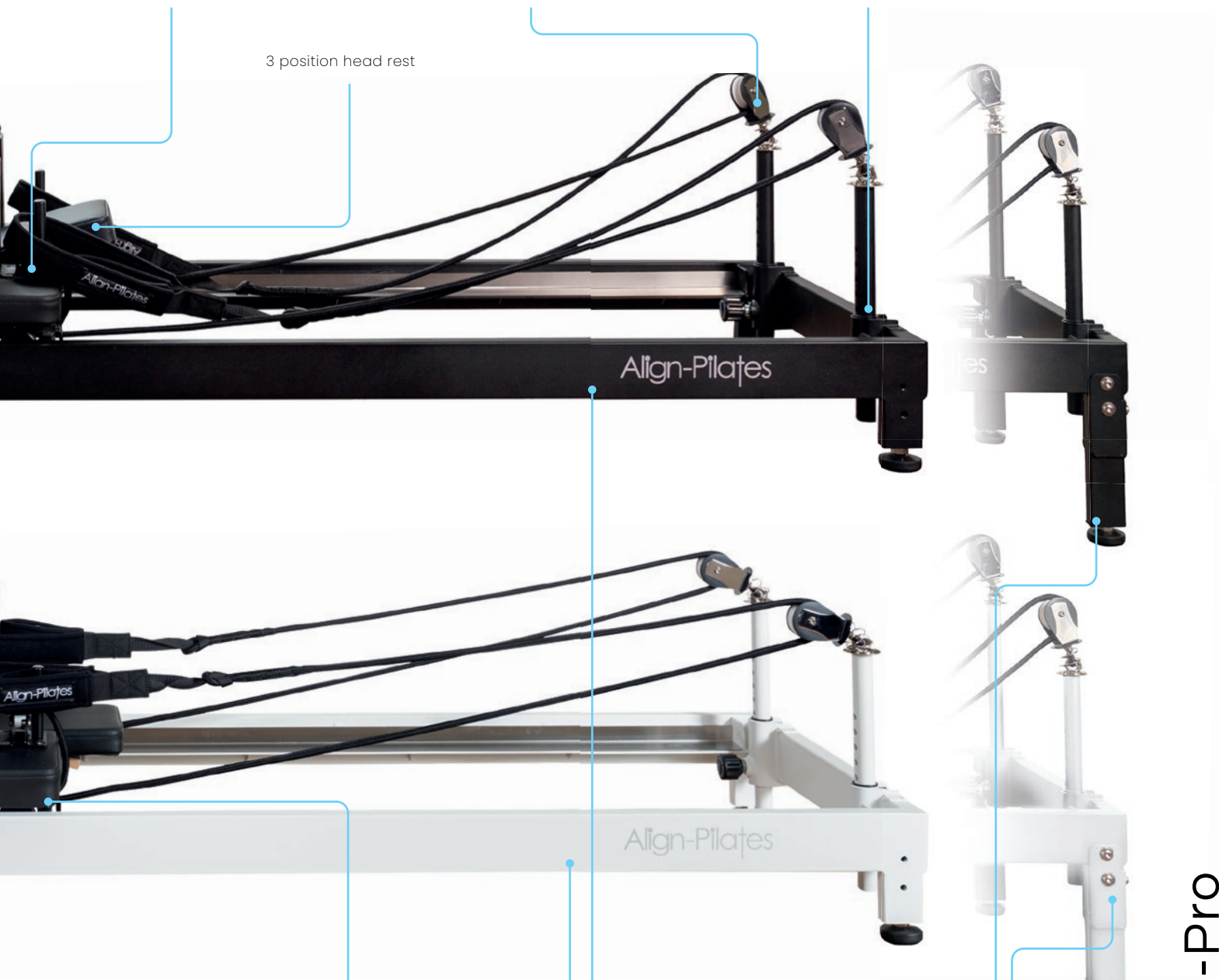

97.5cm Carriage Travel

Stylish stainless steel frame in black or white

Optional Leg Extensions to
raise Reformer height to 36cm



F3 Folding



The F3 Folding Pilates Reformer takes the world's most popular folding Reformer, the F2, to new heights with a completely revised carriage and the introduction of aluminium runners for an even smoother ride.

The F3's innovative carriage never crosses the folding joint so in use you cannot even tell you are using a

folding Reformer, whilst the new aluminium runners offer reduced weight, an extremely smooth ride and a 2cm increase in travel to 97cm.

The F-Series was developed to bring the benefits of a Pilates Reformer workout into your home, without the need to have a dedicated space. The F3 features the same high quality springs found in our commercial



Reformers — though there are four springs instead of the standard five. The spring choice being 1 × Light, 1 × Medium, and 2 × Strong ensures the F3 offers ample versatility and progressive resistance.

The most unique feature of the F3 Folding Pilates Reformer is that it folds up in a matter of minutes into a compact and self-contained machine. The F3

design enables easy mobility and storage, making it an ideal choice for those seeking a home Reformer without sacrificing the key features found on Reformers found in a studio setting. The wheels at the base of the Reformer also means you can effortlessly wheel it around and store it securely out of the way, maximising the use of space in your home.

F3 Folding



What's Included?

- Integral standing platform
- Pair of Silent Double Loop Straps
- 4 nickel plated quality music wire springs in 3 different strengths: 1 × light, 1 × medium and 2 × strong

Optional Extras

- Planking Handles
- Silent Foot Strap with Fluffy
- Jump Board
- Sitting Boxes
- Neck Pillow

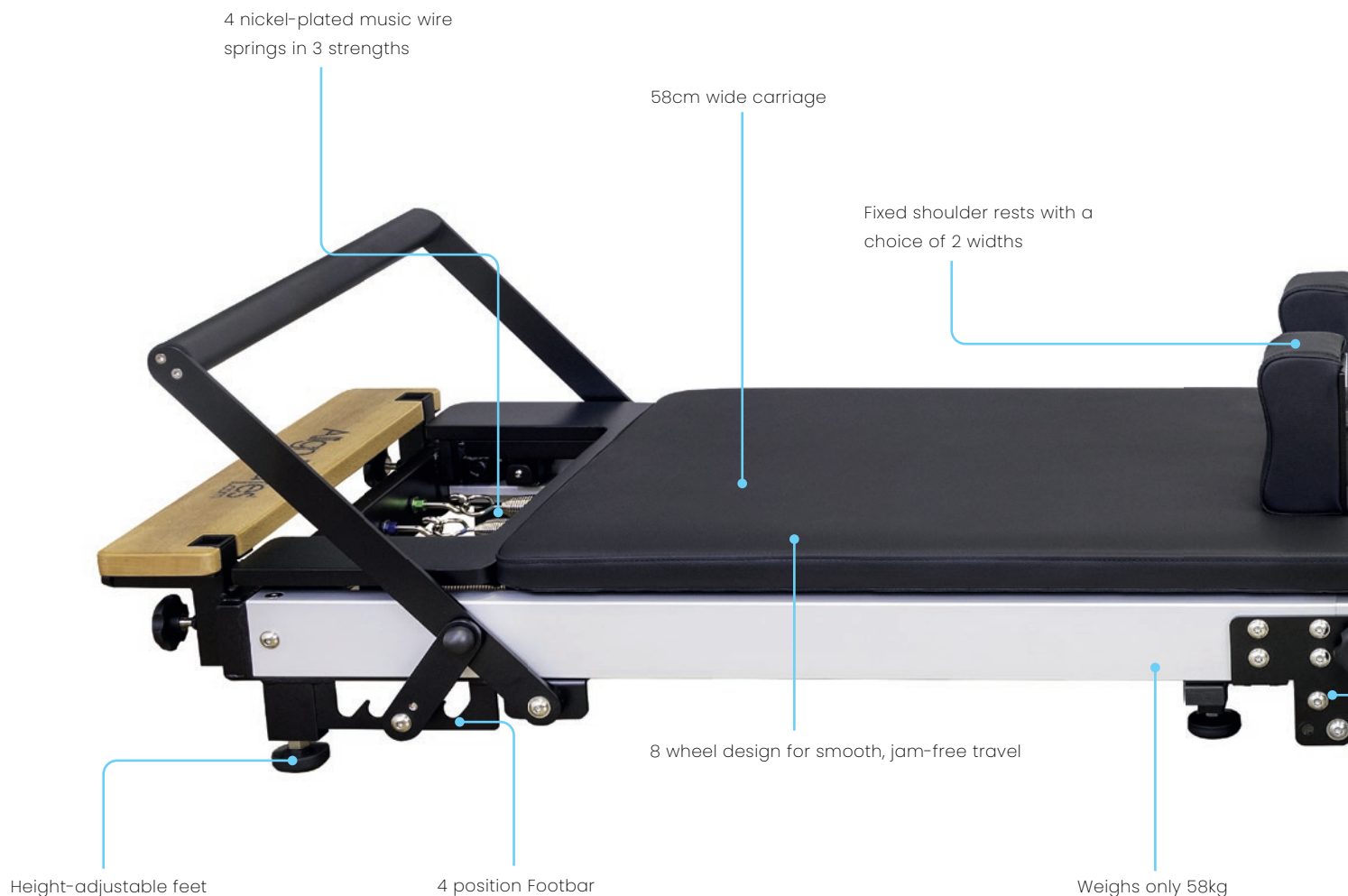

Find Out More



FEATURES
VIDEO



ASSEMBLY
VIDEO

Product Options

Product	Dimensions	Code
F3 Folding Pilates Reformer	242cm (L) × 66cm (W) × 23cm (H) Folded: 143.5cm (H) × 66cm (W) × 49cm (D)	PAPREFORMERF3
F3 Folding Pilates Reformer With Jump Board	242cm (L) × 66cm (W) × 23cm (H)	PAPF3BUNDLE1
F3 Folding Pilates Reformer With Jump Board, Sitting Box & Foot Strap	242cm (L) × 66cm (W) × 23cm (H)	PAPF3BUNDLE2

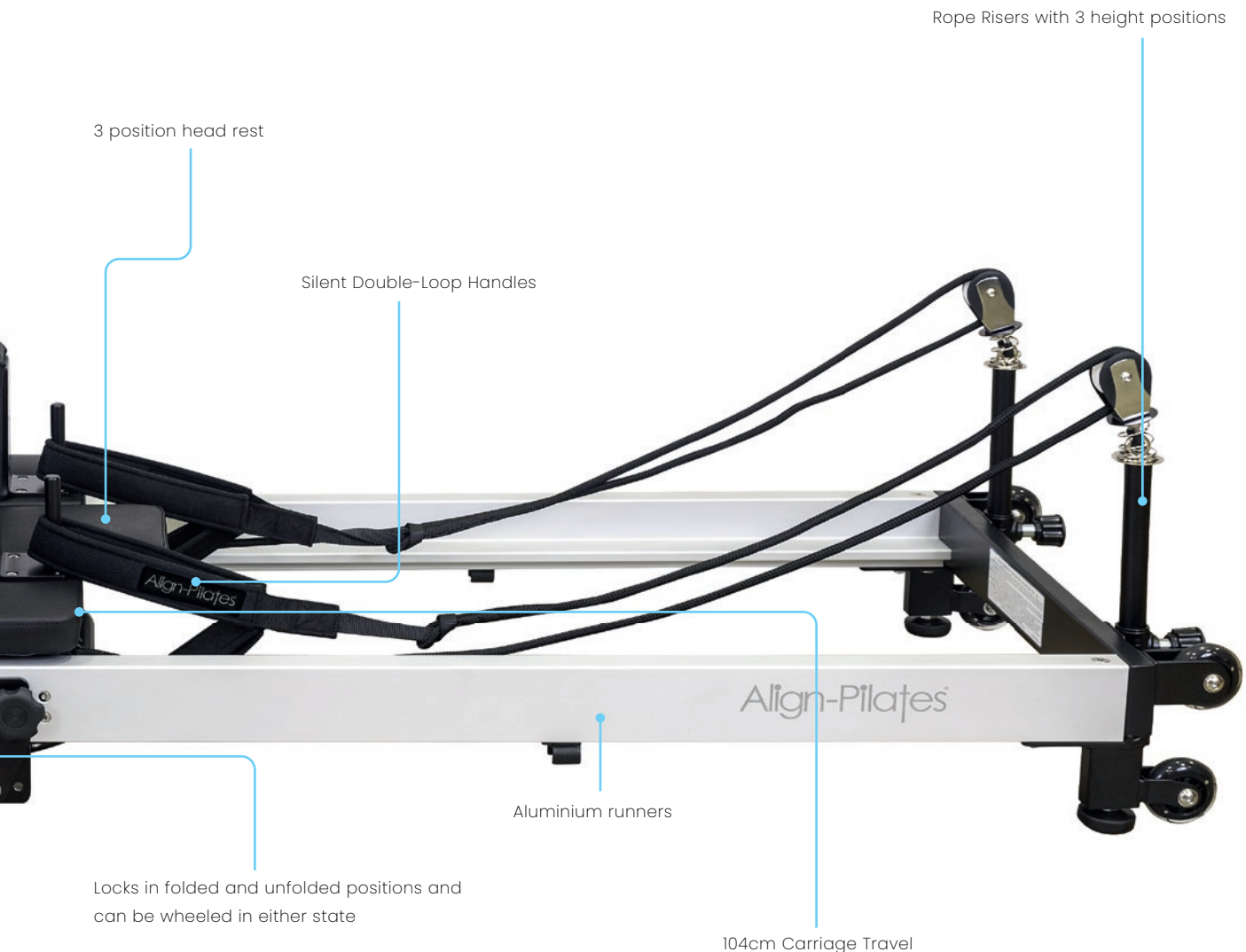



Half Cadillac



Our Half Cadillac, also known as a Half Trapeze/Tower, provides additional versatility and exercise options, either to the Reformer or independently, and allows a broader range of repertoire.

Our unique Half Cadillac can either work by attaching to our A, C and M-Series Reformers (with the right Bracket) or can be used with the Wall Unit Adapter and attach directly to your wall. Our Half Cadillacs can be bought with a Reformer, or can be added at a later date, and works with all leg height options.

As standard, our Half Cadillac comes with a Swing Through Bar, a Roll Down Bar, and our sliding eyelets, which allow multiple planes of resistance for a variety of exercises.

2024 also sees the introduction of a dedicated C-Series Half Cadillac, which is narrower, fitted for the C8-Pro Reformer, and more in-keeping with its compact design – although the larger frame of the original Half Cadillac is still an option.

Find Out More



VIEW
ONLINE



ASSEMBLY
VIDEO

Product Options

Product	Dimensions	Code
Half Pilates Cadillac (Frame Only)	189cm (H) from floor	PAPHALFCADA2
Half Pilates Cadillac (Fitted For C8-Pro)	189cm (H) from floor	PAPHALFCADC8
Half Pilates Cadillac With Wall Bracket	202.5cm (H) × 80.5cm (W) × 56cm (D)	PAPHALFCADA2WALLSET
Bracket For M-Series Reformers	11.5cm (L) × 21.5cm (H)	PAPM2PHALFCADBKT
Bracket For C*-Series Reformers	11.5cm (L) × 21.5cm (H)	PAPCIPROHCADBKT
Bracket For C8-S Pro Reformer	22cm (L) × 30.5cm (W) × 35cm (H)	PAPC8SHCADBKT
Bracket For A-Series Reformers	11.5cm (L) × 21.5cm (H)	PAPA2HALFCADBKT
Half Pilates Cadillac Wall Bracket	56cm (D)	PAPHALFADAPTA2

Also available as part of bundles with the A8-Pro and C8-Pro – see Reformer pages for details.

Bracket for C-Series Reformers is not compatible with C1 & C8-S Pro.



What's Included?

- Stainless steel frame
- Maple Roll-Down Bar
- Aluminium Push-Through Bar with rapid-adjust height changers
- Quick-release safety strap
- 1 pair of Foot Straps
- 1 pair of handles
- 2 pairs of rapid-adjust, double-eyelet spring holders
- Spring Package: 2 × 47cm Very Light Springs, 2 × 47cm Medium Springs, 2 × 64cm Light Springs, 2 × 64cm Strong Springs



Full Cadillac



The Full Cadillac is a single frame that has two distinct options: firstly, as a Reformer/Cadillac combo (with the C8-Pro, shown above, plus appropriate brackets) – maximising the benefits of a Reformer while incorporating Cadillac functionalities – and secondly, it can function independently as a standalone Full Cadillac with our A2 Base Frame.

The next page shows our A2 Full Cadillac, which features an oversize solid bed (78cm × 206cm).

In both options, our Full Cadillac Frame gives the ease of adjustment and multiple anchor points to facilitate numerous exercises. The full stainless steel upper frame is superior to standard chromed steel frames, ensuring a long and corrosion free life. The Full Cadillac is supplied complete with all the required accessories so there are no expensive add-on purchases required.

Find Out More



VIEW
ONLINE



ASSEMBLY
VIDEO



What's Included?

- Full Cadillac
- 1 trapeze with fluffy foot support
- 1 pair of Fuzzy handles
- 1 pair of Foot Straps
- 1 pair of Hand Handles
- 2 pairs of rapid adjust double eyelet spring holders
- 14 aluminium Carabiners
- 10 double ended dog clips
- 1 Belly Strap
- 2 Adjustable Fluffies
- Spring Package: 2 × 47cm Very Light Springs, 2 × 47cm Light Springs, 2 × 47cm Medium Springs, 2 × 47cm Very Strong Springs, 2 × 64cm Light Springs, 2 × 64cm Strong Springs

Product Options

Product	Dimensions	Code
A2 Full Pilates Cadillac	216cm (L) × 76cm (W) × 216cm (H)	PAPCADA2FULLFRAME
Full Pilates Cadillac (Frame Only)	216cm (L) × 76cm (W) × 216cm (H)	PAPCIPROFCAD
Full Pilates Cadillac Bracket For C*-Series Reformers	11.5cm (L) × 21.5cm (H)	PAPCIPROFCADBKT
Half Pilates Cadillac Bracket For C*-Series Reformers (required in combination with Full Cadillac Bracket)	11.5cm (L) × 21.5cm (H)	PAPCIPROHCADBKT

Also available as part of a bundle with the C8-Pro – see Reformer pages for details.

Bracket for C-Series Reformers is not compatible with C1 & C8-S Pro.



Fuse Ladder II



Meet the Fuse Ladder II, a dynamic new piece of apparatus designed by Fuse Pilates: Washington, D.C.'s most popular Pilates studio. After extensive development in their studio, Fuse Pilates worked with Align-Pilates to create the latest version – complete with quick adjust springs, a padded backboard, and moveable eyelets.

The Fuse Ladder II appeals to students and teachers who want a functional fitness workout that's tough,

unique, and ever-changing. It is also less expensive than most Reformers or weight machines and takes up much less space, which can then be used for mat-based classes, doubling your Studio's offering.

Low ceilings won't hold you back from accessing the Fuse Ladder's total fitness and rehab potential – you can shorten our new model by up to 9 inches to bring multi-planar movement magic into even the smallest spaces.

Find Out More



FEATURES
VIDEO



VIEW
ONLINE

Product Options

Product	Dimensions	Code
Fuse Ladder II	237cm (H) × 80cm (W) × 49cm (D)	FUSELADDER2
Swing Through Bar	11.5cm (L) × 67cm (W) × 85cm (H)	FUSESINGTHRU

What's Included?

- 1 × Roll Down Bar
- 1 × Padded Back Board which hooks onto the ladder
- 2 × pair of Sliding Spring Eyelets
- 5 × Fixed Eyelets
- 1 × pair of Hand/Foot Straps with double D-rings and metal clips
- 1 × moveable padded rung wrap
- 1 × pair of Handles
- Spring Package: 2 × 47cm Extra Light Springs, 2 × 64cm Light Springs, 2 × 64cm Medium Springs



Fuse Ladder II



Ladder Barrel RC



The Ladder Barrel RC is designed to offer fast adjustment of the barrel to make it quicker and easier to set the barrel up correctly for different sized users or exercises. To adjust the barrel, simply open the two quick-release cam levers, slide the barrel in or out, and close the levers. Like its predecessor, the RC Ladder Barrel offers industry leading levels of adjustment with 31cm of adjustability. In addition, the apparatus comes complete with 2 padded standing

boards (often sold separately for around £100) which makes it easy to get the perfect set up for all user heights.

The RC Ladder Barrel arc and dimensions have been revised and now closely match classical proportions and the 4 rungs provide different hand and foot placement options, allowing you to perform various exercises at different heights and angles.

Find Out More



FEATURES
VIDEO



ASSEMBLY
VIDEO

Product Options

Product	Dimensions	Code
Ladder Barrel RC – Built	125cm (L) × 90cm (W) × 105m (H)	PAPLADDERRCBUILD
Ladder Barrel RC – Flat Packed	125cm (L) × 90cm (W) × 105m (H)	PAPLADDERRC

What's Included?

- Two padded standing boards worth over £100
- Padded zip-on rung wrap



Ladder Barrel RC



Combo Chair III



The Combo Chair III is the latest iteration of Align-Pilates' popular Wunda Chair. Though it looks similar to its predecessor, the Combo Chair III features a number of significant enhancements to refine the smoothness and quietness of operation, taking this chair to new levels. The new features include an updated pedal locking mechanism, a revised pedal axle with roller bearings, new rubber-coated

Silent spring hooks, and a chromed Spring Tree for improved durability.

Our unique features include an easily adjustable split pedal system, allowing for independent movement of each leg or foot. Our design also has an easy accessible Spring Tree, meaning this Combo Chair can be stored and adjusted whilst against the wall.

Find Out More



FEATURES
VIDEO



ASSEMBLY
VIDEO

Product Options

Product	Dimensions	Code
Combo Chair III – Built	64cm (H) × 55cm (W) × 82.5cm (D)	PAPCHAIR3BUILD
Combo Chair III – Flat Packed	64cm (H) × 55cm (W) × 82.5cm (D)	PAPCHAIR3

What's Included?

- Removable and adjustable handles with anti-slip grips
- Fastener for optional extra Jump Board
- Eyelets for optional extra Resistance Bands
- Spring Package: 2 × Strong Springs, 2 × Extra Strong Springs

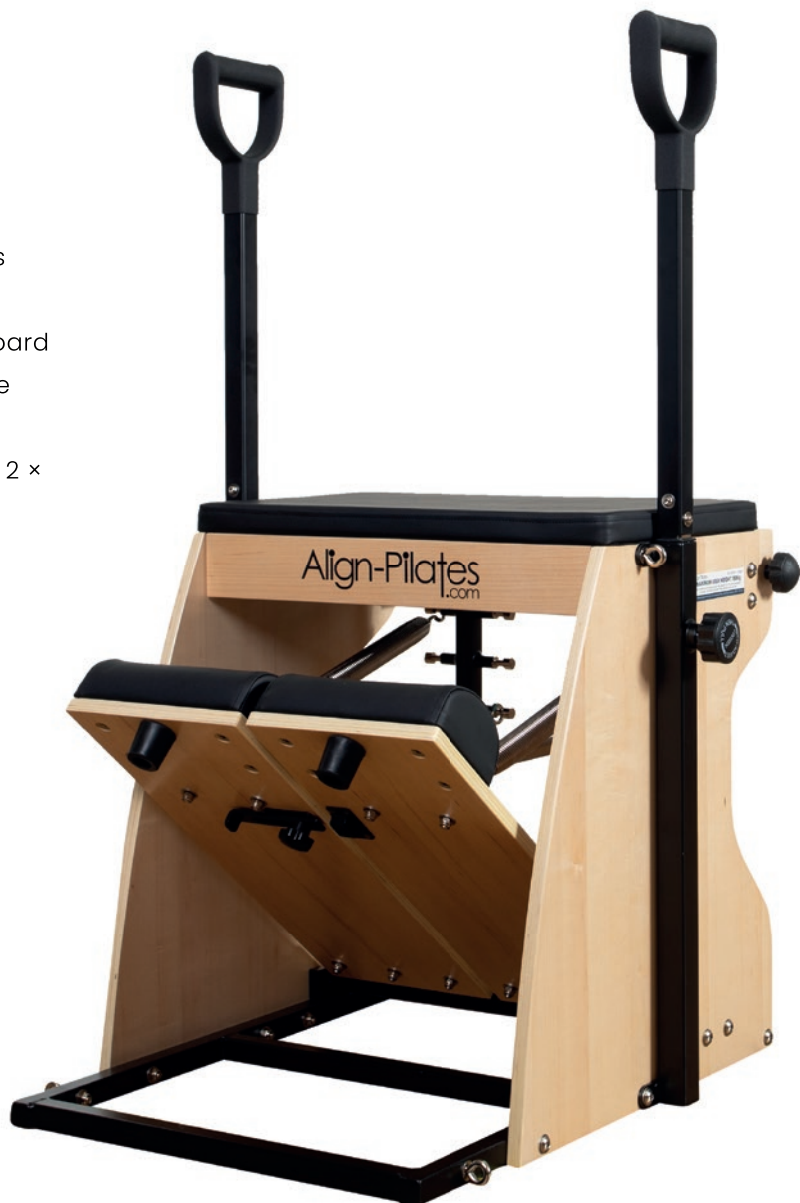

Combo Chair III

Boxes & Arcs

Pro Sitting Box

The Align-Pilates Pro Sitting Box not only makes new exercises possible on your Pilates Reformer, but also makes seated/prone exercises more comfortable. It is suitable for use on all Pilates Reformer brands and also offers top quality finishing and the best value available in Europe.



Frame Sitting Box

The Align-Pilates Frame Sitting Box is a little smaller than our Pro & Curved Sitting Boxes, making it ideal for smaller Reformer carriages, for example the earlier C-Series, F-Series, and H-Series Reformers. The Frame Sitting Box not only makes new exercises possible on your Pilates Reformer, but it makes seated and prone exercises more comfortable.

Curved Pro Sitting Box

The Align-Pilates' Curved Pro Sitting Box features Rounded sides for Long Box exercises that aid comfort in supine position. Slightly smaller in size than our Pro Sitting Box, this gives another option that can be used on all brands of Pilates Reformers.



Head Support Box

Introducing the Head Support Box, an essential accessory designed to provide head support during various exercises using the Pro and Curved Sitting Box on the Pilates Reformer. Beyond providing support, it plays a key role in maintaining correct head alignment as it enhances posture and reduces strain, particularly for users engaging in exercises while lying on their back on the sitting box.

Modular Step Barrel & Arc

The Modular Step Barrel & Arc (also known as the 'Spine Corrector') adds extensively to the core functionality of the traditional Step Barrel, which has long been known to help improve posture by lengthening and strengthening the back, feet, and shoulder muscles. Slots conveniently over the shoulder rests of all Align-Pilates Reformers so that it can be used on the Reformer as well as the floor. The Arc is also removable, as well as locking in place, so this can be used independently.



Stacking Arc Barrel

Arc Barrels are great for adding an extra dimension to matwork classes, offering various workout possibilities that help to improve posture, lengthen, and strengthen the back, feet, and shoulder muscles.

Product Options

Product	Dimensions	Code
Pro Sitting Box	70cm (L) × 40cm (W) × 28cm (H)	PAPBOX
Frame Sitting Box – Built	64cm (H) × 55cm (W) × 82.5cm (D)	PAPBOXMBUILT
Frame Sitting Box – Flat Packed	38cm (L) × 66cm (W) × 25cm (H)	PAPBOXM
Curved Pro Sitting Box	69.5cm (L) × 37.5 (W) × 26cm (H)	PAPBOXCURVE
Head Support Box	26cm (L) × 18.6cm (W) × 28cm (H)	PAPBOXHEAD
Modular Step Barrel & Arc	79cm (L) × 48cm (W) × 34cm (H)	PAPSTEP3
Stacking Arc Barrel	60cm (L) × 55cm (W) × 19.5cm (H)	PAPARCST



Reformer Accessories

A-Series Cardio Jump Dome

The Cardio Jump Dome provides a cushioned landing surface when performing Jump Board exercises on the A-Series Reformers.



Product	Code
A-Series Cardio Jump Dome	PAPJUMPOME

Jump Boards

The Align-Pilates Jump Boards provide you with a firm and stable platform for plyometric exercises and is one of the most popular accessories for the Pilates Reformer.



Product	Code
Jump Board For A-Series & MI Reformers	PAPJUMPA2
Jump Board For C, F & H-Series Reformers	PAPJUMPC1
Jump Board For M*-Series Reformers	PAPJUMPM2P

Mattress Converters

Extend your Align-Pilates Reformer with the addition of the mattress converter which, with the Platform Extender, converts your Reformer into a completely flat bed.

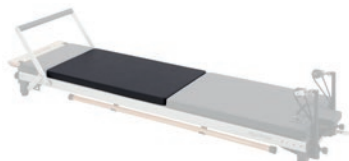

Product	Code
Mattress Converter For A-Series Reformers	PAPMATA2
Mattress Converter For C-Series Reformers	PAPMATCIMC
Mattress Converter For M*-Series Reformers	PAPMATM2P

Platform Extenders

Add a Platform Extender for an extra bit of padding for the feet when performing standing or kneeling exercises.

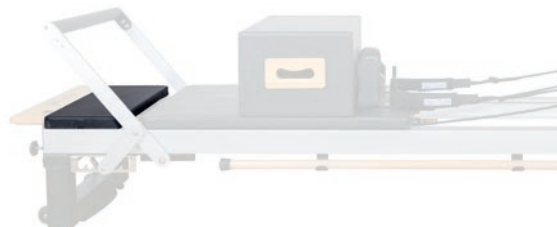

Product	Code
Platform Extender For A-Series Reformers	PAPMATPLATA2R
Platform Extender For C-Series Reformers	PAPMATCIPE
Platform Extender For M*-Series Reformers	PAPMATPLATM2P
Platform Extender For R8-Pro Reformer	PAPMATPLATR8

Neck Pillow

The Neck Pillow fits neatly on to any Reformer head rest to create a soft, cushioned support for the head and neck.



Product	Code
Pilates Reformer Neck Pillow	PAPNECKPAD

Footbar Cover

The Footbar Cover is designed to fit on both of our Footbar sizes and offers a padded surface for a more pleasant and supportive experience.



Product	Code
Pilates Reformer Footbar Cover	PAPFOOTBARCOVER

Jump Board, Mattress Converter, and Platform Extender for M-Series Reformers not compatible with MI Reformer.

Reformer Accessories

Gondola & Roll Up Poles

Gondola Poles are used for aiding balance when performing standing work on the Reformer, and Roll Up Poles are used to aid alignment. We are also expanding the range to add a weighted Metal Pilates Pole – 60".



Product	Code
Gondola Maple Pilates Pole – 60"	PAPPOLE60
Role Up Maple Pilates Pole – 32"	PAPPOLE32
Roll Up Metal Pilates Pole – 32"	PAPPOLE32M
Weighted Metal Pilates Pole – 60"	PAPPOLE60M

Plank Handles

Great for plank-based exercises and are rotatable so they can face in 4 different directions and at 4 different heights.



Product	Code
Plank Handles	PAPPLANKH

Freestanding Legs

Adapt your C8-Pro or C2-Pro RC Pilates Reformer to freestand, in order to save space. Not required with Leg Extensions.



Product	Code
Freestanding Legs for C8-Pro & C2-Pro RC Reformers	PAPCFREELEGS



Anti-Slip Pads

Anti-slip pads are useful to hold a mat on a ladder barrel/arc if extra padding is required. Also available made from TPE which is recyclable & degradable.



Product	Code
Reformer Anti-Slip Pads	PAPANTISLIP
TPE Reformer Anti-Slip Pads	PAPANTISLIPTPE

Carriage Protectors

Carriage protectors add an extra 6mm of cushioning for extra comfort. The padding also adds extra protection to your upholstery & can be wiped clean.



Product	Code
Carriage Protector – A-Series Reformers	PAPA2TOPPER
Carriage Protector – C-Series Reformers	PAPC2TOPPER

Reformer Floor Protection Mats

Designed for use under Align-Pilates Reformer machines. PVC Reformer mats protect floors, dampen sound, and reduce dirt getting into the Reformer.

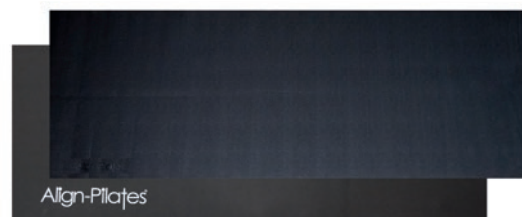

Product	Code
Reformer Floor Protection Mat	PAPFLOORMAT
Reformer Machine Mat	PAPMACHINEI00250BLK

Accessories

Springs

Our springs are made from top quality nickel-plated music wire. Springs are standardised on all Align-Pilates equipment, except the Combo Chair.



Reformer/Cadillac Springs	Code
47cm – Very Light	PAPSPRINGSVLIGHT
Supported Spring Cover For Very Light Spring	PAPSPRINGCOVERS
47cm – Light	PAPSPRINGSLIGHT
47cm – Medium	PAPSPRINGSMED
47cm – Strong	PAPSPRINGSSTRONG
64cm – Very Light, Light, Strong	PAPSPRINGL

Combo Chair Springs	Code
47cm – Strong	PAPSPRINGCHS
47cm – Extra Strong	PAPSPRINGCHXS



Washable Loop Straps

Made from soft, comfortable neoprene material so they can be wiped down much more effectively whilst also being machine washable.



Combo Hand-Foot Strap (Silent)

The quadruple-stitched “Silent” design means an improved user experience. Suitable for use on the Reformer, Half Cadillac, and Full Cadillac.



Combo Hand-Foot Strap (Double Ring)

Add variety to your workout with this Combo Strap. Suitable for use on the Reformer, Half Cadillac, and Full Cadillac. Sold in pairs.



Silent Foot Strap

The Silent Reformer Foot Strap is perfect for adding variety to your Reformer workout. Especially comfortable for exercises using the Align-Pilates Pro Sitting Box, Curved Pro Sitting Box, and Frame Box.



Extension Straps For Pilates Cadillacs

Align-Pilates' Pair of Extension Straps are great for adding additional length to springs on your Pilates Cadillac.



Ankle Straps (Pair)

Align-Pilates Ankle Straps are great for adding variety to leg work on your Pilates Cadillac.



Padded Handles (Pair)

These high-quality durable Pair of Handles is for use with the Half or Full Pilates Cadillac.



Product	Code
Washable Double Loop Pilates Reformer Straps	PAPSTRAPPSL
Combo Hand-Foot Strap (Silent)	PAPSTRAPDLS
Combo Hand-Foot Strap (Double Ring)	PAPSTRAP
Silent Pilates Reformer Foot Strap	PAPFOOTSTRAP
Pair Of Extension Straps For Pilates Cadillacs	PAPEXTENSION
Pilates Cadillac Ankle Straps (Pair)	PAPANKLE
Pair Of Handles For Half & Full Pilates Cadillac	PAPHANDLE

Cadillac Safety Strap

The safety strap is designed to be used with the Half Cadillac and Full Cadillac to hold the swing through bar when being sprung from the underside and prevent it from falling further than its chosen position.



Product	Code
Safety Strap For Full & Half Cadillacs	PAPSAFETYSTRAP



Cadillac Fluffy (Adjustable Height)

Fluffy for use with our Full Cadillac.



Product	Code
Fluffy for Full Cadillac	PAPCADFLUFFY

Cadillac Belly Strap

Black Belly Strap for use with our Full Cadillac.



Product	Code
Cadillac Belly Strap	PAPBELLYSTRAP

Cadillac Brackets

Modifies Reformers to allow combination with certain Cadillacs.



Product	Code
Half Pilates Cadillac Bracket For M-Series Reformers	PAPM2PHALFCADBKT
Half Cadillac Bracket For C8-S Pro Reformer	PAPC8SHCADBKT
Half Pilates Cadillac Bracket For C*-Series Reformers	PAPC1PROHCADBKT
Full Pilates Cadillac Bracket For C*-Series Reformers	PAPC1PROFCADBKT
Half Pilates Cadillac Bracket For A-Series Reformers	PAPA2HALFCADBKT
Half Pilates Cadillac Wall Bracket	PAPHALFADAPTA2

Brackets for C-Series Reformers are not compatible with C1 & C8-S Pro.



Matwork Accessories

Double Handle Pilates Ring

Lightweight double handle Pilates rings (also known as a magic circles) are commonly used in Pilates to add intensity to floor exercises.



Product	Code
Double Handle Pilates Ring – 12"	PAPRING12L
Double Handle Pilates Ring – 14"	PAPRING14L

Pro Pilates Ring

The Pro Edition Pilates Ring features a double handle design and quality sprung steel rings.



Product	Code
Pro Pilates Ring – 12"	PAPRING12
Pro Pilates Ring – 14"	PAPRING14

Rotational Disks (Pair)

Rotational Disks are used to develop balance and strength through rotation whilst standing or sitting.



Product	Code
Pilates Rotational Disks 12" – Pair	PAPROTATION

Pro Soft Pilates Weights

These Align-Pilates Pro Soft Weights are ideal for Pilates, plyometrics, balance training, and mobilisation exercises. In addition to offering a more fluid range of motion to using a standard dumbbell, the soft weight design is safer due to their soft-shell design, reducing the risk of damage or injury if dropped.



Product	Code
Pro Soft Pilates Weights – Pair Of 0.5kg	PAPSOFT1
Pro Soft Pilates Weights – Pair Of 1kg	PAPSOFT2
Pro Soft Pilates Weights – Pair Of 1.5kg	PAPSOFT3

Exer-Soft Balls

The Align-Pilates Exer-Soft Ball (also known as an over ball) is perfect for matwork and use on a Pilates Reformer and apparatus or part of a physiotherapy and rehabilitation routine. It can be used to aid a workout or to make it more challenging by providing resistance; use under the lower back for support or between the knees, ankles, or hands.



Product	Code
7" Exer-Soft Pilates Ball – Purple	PAPEXBALL7
9" Exer-Soft Pilates Ball – Blue	PAPEXBALL9
12" Exer-Soft Pilates Ball – Graphite	PAPEXBALL12

Pilates Blocks

Pilates Blocks can be used for numerous exercises and provide many different levels of depth to adjust the level of difficulty of exercises for all clients.

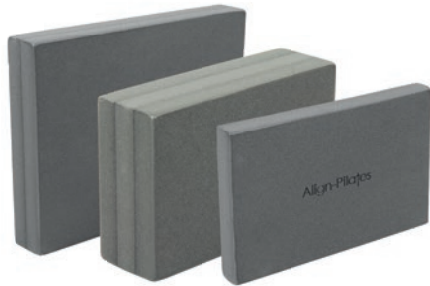

Product	Code
1" x 6" x 9" Pilates Block	PAPBLOCK169
3" x 6" x 9" Pilates Block	PAPBLOCK369
2" x 10" x 13" Pilates Block	PAPBLOCK21013

Pilates Resistance Bands

Resistance bands are a great way to train as they are extremely versatile piece of kit. They can add resistance to bodyweight or weighted workouts, plus they are perfect for Pilates or toning exercises too. Can also be used on the Align-Pilates Combo Chair through the eyelets to add an arm repertoire.



Product	Code
Pilates Resistance Band – Level 1 (Light)	PAPRESBAND1
Pilates Resistance Band – Level 2 (Medium)	PAPRESBAND2
Pilates Resistance Band – Level 3 (Strong)	PAPRESBAND3

Pilates Studio Mats

Align-Pilates Studio Mat balances size and weight offering excellent cushioning and memory. Perfect for Pilates matwork classes and any Pilates studio.



Product	Code
Pilates Studio Mat – 10mm	PAPMAT10
Pilates Studio Mat – 10mm With Eyelets	PAPMAT10EYE

Exercise Mat Rack

Adjustable Mat Rack available for use with eyelet mats like the Align-Pilates Studio Mat with Eyelets.



Product	Code
Exercise Mat Rack for Eyelet Mats	FMATRACK20

Reformer Comparison

Not sure which Reformer to go for? Use our Reformer comparison tool below! Compare features or visit our website for a full comparison:



REFORMER
COMPARISON

Name	A8-Pro	C8-S Pro	C8-Pro	M8-Pro	R8-Pro	F3 Folding
Usage/Warranty	Studio	Studio	Studio	Studio	Light Studio	Home
Dimensions/ Weight	263 × 75cm/ 75kg	243 × 67cm/ 55kg	244 × 66cm/ 55kg	254 × 76cm/ 80kg	248 × 67cm/ 54kg	242 × 66cm/ 58kg
Leg & Height Options	3 leg options (28, 42, 64cm high)	2 leg options (26, 42cm high)	2 leg options (26, 42cm high)	None	2 leg options (23, 36cm high)	None
Carriage Size	67 × 91cm	58 × 91.5cm	58 × 91.5cm	66 × 93cm	56 × 89cm	58 × 89cm
Travel Length	113cm	105cm	106.5cm	104cm	97.5cm	97cm
Rope Adjustment System	Pro Rope Adjusters for precise adjustments	Pro Rope Adjusters for precise adjustments	Pro Rope Adjusters for precise adjustments	T bar system, both ropes adjust together	Pro Rope Adjuster within Shoulder Rest frame	Threaded rope
Footbar	6 lockable positions, oversize	4 lockable positions, oversize	4 lockable positions, oversize	4 lockable positions, standard size	5 lockable positions, standard size	4 positions, standard size
Spring Bar & Spring Bar Adjustment	Rapid change spring bar	Rapid change spring bar	Rapid change spring bar	Rapid change spring bar	Rapid change spring bar	Fixed
Springs	5 springs (1 × Strong, 2 × Medium, 2 × Light)	5 springs (1 × Strong, 2 × Medium, 2 × Light)	5 springs (1 × Strong, 2 × Medium, 2 × Light)	5 springs (1 × Strong, 2 × Medium, 2 × Light)	4 springs (2 × Strong, 1 × Medium, 1 × Light) with space for 5th	4 springs (2 × Strong, 1 × Medium, 1 × Light)
Off Centred Shoulder Rests	Yes	Yes	Yes	Yes	Yes, but fixed	Yes, but fixed
Adjustable Feet	Yes	Yes	Yes	No	Yes	Yes
Runners/Wheels	Precision aluminium/8 PU wheels	Precision aluminium/8 PU wheels	Precision aluminium/8 PU wheels	Precision aluminium/8 PU wheels	Stainless steel runners/8 PU wheels	Precision aluminium/8 PU wheels
Maximum User Weight	150kg	150kg	150kg	150kg	120kg	120kg
Rope Risers	Stainless, outside frame. 5 Heights.	Stainless, inside frame. 9 heights (with legs)	Painted, outside frame. 7 heights (with legs)	Maple, outside frame. Fully adjustable.	Painted, outside frame. 9 heights (with legs)	Painted, outside frame. 3 heights.
Folding/ Standing/ Stacking	No/No/Yes (but heavy)	No/Yes/Yes	No/Yes/Yes	No/No/No	No/Yes but only with optional Jump Board/Yes	Yes/Yes/No



Sock Only Studio?

Many Pilates studios are increasingly requiring their clients to wear socks in order to partake in classes. Tavi, ToeSox, and Base 33 Grip Socks not only improve hygiene, comfort, and safety on a Reformer, but also provide studio owners with an opportunity for an extra revenue stream by stocking them – giving clients an option if they come to class unprepared!

TAVI™



Initially created by instructors for instructors, it didn't take long before TAVI grip socks and apparel were seen in studios everywhere.

toeSOX®



When ToeSox created a sock with 5 toes, people asked why. Then they tried them – and they never went back to regular grip socks again.

BASE
X X X I I I



Base 33 don't follow a rule book; instead, they pay attention to how you train and create socks that support your performance.

Align-Pilates' sister company – The Mad Group – are the exclusive distributors of Tavi, ToeSox, and Base 33 in the UK. If you are interested in supplying your clients with stylish, high-performance grip socks, and other activewear, in an ever-changing range of seasonal colours, then get in touch.



Pilates Teacher Or Studio Owner?

Get discounts on a huge range of Pilates, yoga, and fitness accessories with one of our trade accounts – visit align-pilates.com/trade-account-application for details.

STUDIO BOOKLET



INTERNATIONAL DISTRIBUTORS



ALIGN-PILATES EXHIBITIONS



FOR BUSINESSES



Interest-Free Finance

Align-Pilates are pleased to offer UK customers 0% finance offers on all of our Pilates Reformers, Studio apparatus, and smaller accessories. Therefore, there has never been a better time to open the Pilates Studio you have been dreaming of! Adding an extra piece of Pilates equipment you have been wanting, or upgrading your Studio is now even easier. Most importantly, with our interest-free credit, you can spread your repayment over 6, 12, or even 24 months giving you extra time when getting your Pilates business up and running!

- 0% finance is available to individuals only, not limited companies
- Minimum order: £250 for 6 months interest free or, £1,000 for 12 and 24 months interest-free
- Minimum deposit: 25% for 6 and 12 months, or 50% for 24 months interest-free credit
- Max. loan amount: £15,000 inc. VAT
- Interest free credit cannot be used in conjunction with any other offers unless indicated and is subject to approval
- Interest free credit cannot be used in conjunction with other offers or discounts unless indicated and is subject to approval

Please call or email us using the details below so we can discuss your requirements and tailor a package to suit your business expansion plans.

Interest-Free Credit will be offered through our sister company The Mad Group (HQ) Ltd, who is the official outlet for Align-Pilates Equipment in the UK. 0% finance is provided by: V12 Retail Finance Limited. Registered in England and Wales 4585692. Authorised and regulated by the Financial Conduct Authority. Registration number – 679653. Registered Office – One Arleston Way, Solihull, B90 4LH. Correspondence Address: 20 Neptune Court, Vanguard Way, Cardiff, CF24 5PJ.

Get In Touch



align-pilates.com



+44 (0)1386 425 923



sales@align-pilates.com

Follow Us



[align_pilates_hq](https://www.instagram.com/align_pilates_hq)



[AlignPilatesHQ](https://www.youtube.com/AlignPilatesHQ)



[alignpilates_hq](https://twitter.com/alignpilates_hq)



[alignpilateshq](https://www.facebook.com/alignpilateshq)



[alignpilateshq](https://www.tiktok.com/alignpilateshq)

Align-Pilates™ is a registered trademark of Align-Pilates Equipment Ltd. in a number of countries or regions. For details of this and other intellectual property rights, please visit align-pilates.com/resources/patents-intellectual-property/

Align-Pilates Equipment Ltd., 430 Enterprise Way, Vale Park, Evesham, Worcestershire, WR11 1AD

Tel: +44 (0)1386 425 923 / Fax: +44 (0)1386 424 535 / Email: sales@align-pilates.com

Registered in England No. 09206328. EORI GB164182414000.

In the UK, Align-Pilates products are fulfilled by The Mad Group (HQ) Ltd. on behalf of Align-Pilates Equipment Ltd.